

4 3 2 1

F

F

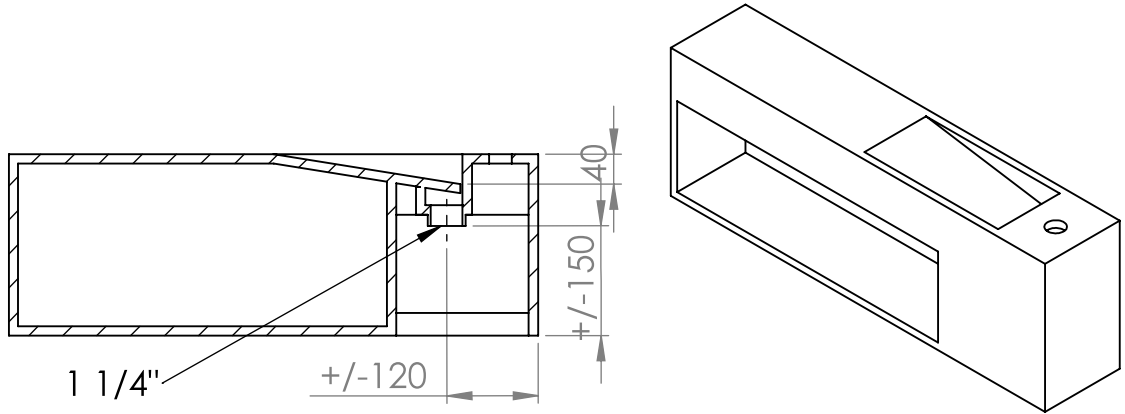

SECTION A-A

E

E

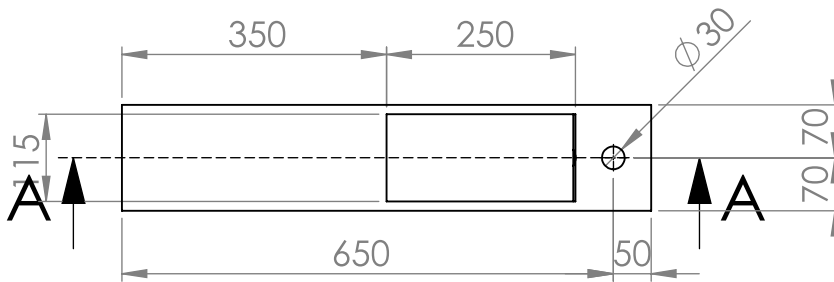

D

D

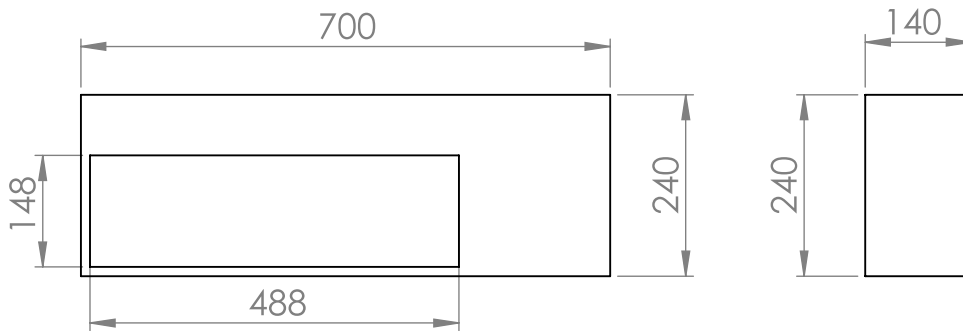

C

C

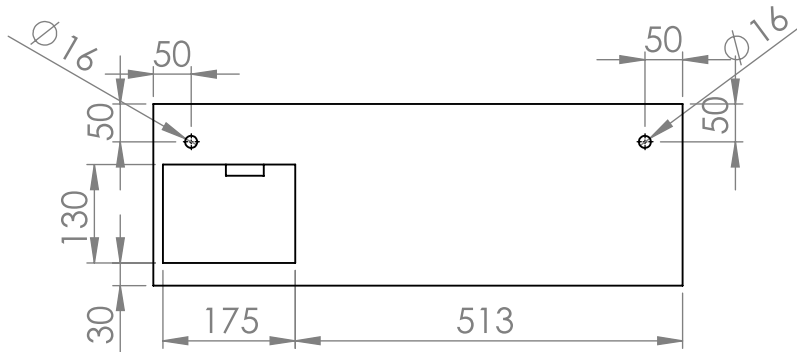

B

B

UNLESS OTHERWISE SPECIFIED:
DIMENSIONS ARE IN MILLIMETERS
SURFACE FINISH:
TOLERANCES:
LINEAR:
ANGULAR:

FINISH:

DEBURR AND
BREAK SHARP
EDGES

DO NOT SCALE DRAWING

REVISION

	NAME	SIGNATURE	DATE
DRAWN			
CHK'D			
APPV'D			
MFG			
Q.A			

TITLE:

Marike[®]

DWG NO.

Marike - Flaq 700 - Right

A4

MATERIAL:

WEIGHT:

SCALE:1:10

SHEET 1 OF 1

4 3 2 1

A

A